



Before installation, you should carefully read this manual, and pay attention to safety cautions and instructions in this manual. Our factory is neither responsible for nor is reliable for paying compensation for personal injury, pump damage and other property losses caused by violation of safety cautions.

1. APPLICATIONS

1) It is applicable to household water supply, equipment support, well water lifting, pipeline pressurization, garden watering, vegetable greenhouse watering, fish farming and poultry raising, etc.

2) Transfer clean water and other non-corrosive liquids with low viscosity; do not transport inflammable, explosive, gasified liquids and liquids containing solid particles or fibers. The PH value should be within 6.5-8.5.

Remark:

This series of pump could be transformed into automatic water pump, which is realized through external automatic plant that is composed of pressure switch, pressure tank, etc. Function features of the automatic pump are as follows: when the power is on, turn on the water tap and the pump will start working automatically; when the water tap is turned off, the pump will stop working automatically. If a water tower is used along with the automatic pump, connect to the upper limit switch and the pump will start or stop working automatically with water level in the water tower.

2. MODEL DESCRIPTION

PEP 05 A 16 S

Features S=Standard
Hertz 5=50hz, 6=60Hz
Phase 1=Single phase, 3=Three phase
Voltage A=115V, C=230V, F=110/220V
HPx10
Series Peripheral Pump

3. TECHNICAL DATA

Max. flow: 90U/min
 Max. head: 1 OOm
 Output power: 0.3-2.2kW
 Max. Suction: 9m
 Insulation grade:IP44
 Protection grade:F
 Max. ambient temperature:+40
 Max. liquid temperature:+40

4. IMPLEMENTATION STANDARDS

IEC/EN 60335-1 Household and similar electrical appliances-safety Part1: General requirements.
 IEC/EN 60335-2-41 Household and similar electrical appliances-safety Part2-41: Particular requirements for pump.
 2006/95/EC Low voltage directive



5. SAFETY PRECAUTIONS

1. To ensure normal and safety operation of the electric pump, read manual carefully before use.

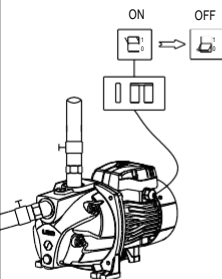
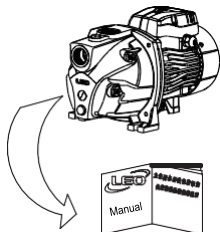

2. The electric pump should have reliable grounding to prevent short circuit; for safety, leakage protection switch should be equipped and be careful no to wet the power plug; socket should be connected in damp - proof area.

3. Do not touch the electric pump while working; do not wash, swim near working area or let livestock into the water to avoid accidents.

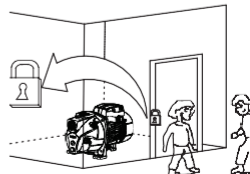

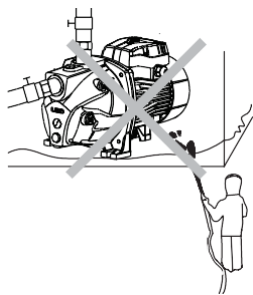

4. Avoid splashing pressurized water to the electric pump as well as prevent the pump immersed by water.

5. Keep the pump in ventilation.

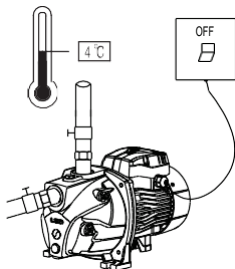
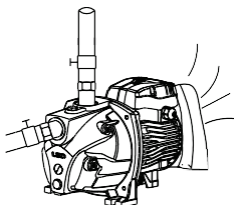

6. In case ambient temperature is lower than 4°C or the pump is not used for a long time, empty liquid the pipeline system to avoid ice cracking of the pump chamber. Do not operate the pump for a long time without water in it.

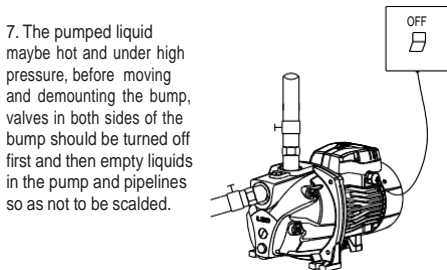

7. The pumped liquid maybe hot and under high pressure, before moving and demounting the bump, valves in both sides of the bump should be turned off first and then empty liquids in the pump and pipelines so as not to be scalded.

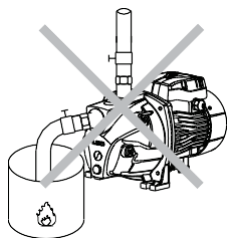

8. Do not transfer any inflammable, explosive or gasified liquids that beyond the stipulation.

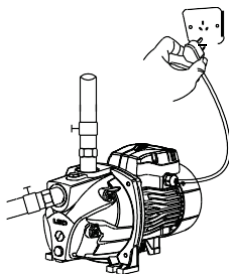

9. Ensure the pump will not be accidentally turned on while installing and maintaining; if not used for a long time, cut off the power first and then turn off valves in inlet and outlet of the pump.

10. Power supply should be in accordance with the voltage stated in the nameplate. If not used for a long time, put the pump in dry, ventilated and cool place under room temperature.

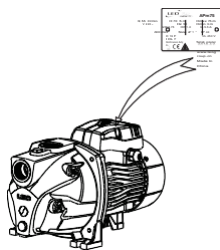

6. Product Structure

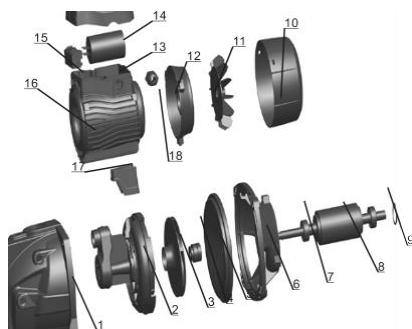

- | | |
|--------------------|--------------------|
| 1. Pump body | 10. Fan cover |
| 2. Diffuser | 11. Fan |
| 3. Impeller | 12. End capacitor |
| 4. Mechanical seal | 13. Capacitor |
| 5. Seal holder | 14. Capacitor box |
| 6. Pump support | 15. Terminal board |
| 7. Bearing | 16. Stator |
| 8. Rotor | 17. Bracket |
| 9. Spring washer | 18. Cable holder |

7. PIPELINE INSTALLATION



This product should be installed and maintained by personnel who is proficient in this manual and has special qualifications. Installation and operation should be in accordance with local regulations and recognized operation standards. Install pipelines properly as stipulated in the manual and meanwhile conduct frost protection measures for the pipeline.

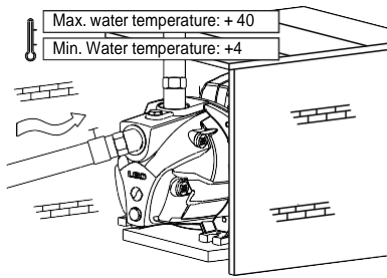

1. For pump installation, the inlet pipe should be as short as possible with the least turnings. The pump should be installed in ventilated and dry environment. It could be installed outside, provided having proper covering to prevent rain and wind.
2. For pipeline use, valves should be installed on inlet and outlet pipelines and the inlet pipeline should be installed with check valve.

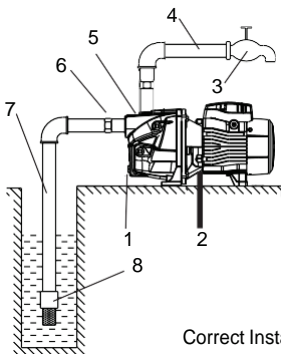

Correct Installation Diagram

A. Installation precautions for inlet pipelines

1. While installing the electric pump, do not use too soft rubber tube for the inlet pipeline, avoiding to be sucked flat.
2. The foot valve should be vertically placed and installed 30cm from water bottom to avoid sucking in sands and stones (82);
3. Joints of the inlet pipelines should be sealed with the least elbows, no water can be sucked.
4. Diameter of the inlet pipe should be at least in accordance with that of the water inlet, so as to avoid too much water loss which will influence outlet performance.
5. Pay attention to drop of water level while using, the foot valve should not be above the water surface (81).
6. In case the inlet pipe is longer than 10m or its lifting height exceeds 4m, the pipe diameter should exceed diameter of water inlet of the pump.
7. Ensure the pumped will not be affected by pipeline pressures while installing the pipelines.
8. Filter should be installed in inlet pipelines so as to avoid solid particles to enter into the electric pump.

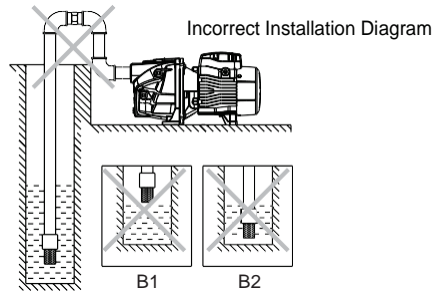

B. Installation Precautions of the outlet pipeline

1. Pipe diameter of the outlet pipeline should be at least in accordance with that of the water outlet, so as to reduce its voltage drop, high flow rate and noise to the minimum.

8. ELECTRICAL CONNECTION

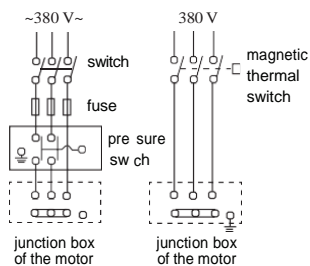
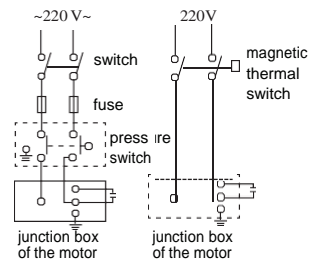
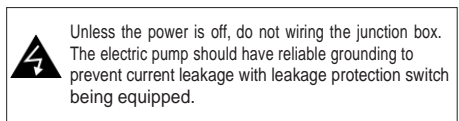

- 1) Electrical connection and protection should be conducted according to stipulations. Specification of working voltage is marked on the nameplate; please ensure the motor is in accordance with power supply.

- 2) In case the working area of the electric pump is too far from the power supply, power transmission lines should be of a heavier gauge, otherwise the electric pump cannot work normally because the voltage drop is too dramatic.

- 3) In case the electric pump is used outdoor, extended lines should apply rubber cables for outdoor use.

4) Check rotation of the motor (three-phase motor)

5) Check whether operation of the electric pump is normal, rotation is correct, which could be observed from the fan blade terminal, e.g. clockwise rotation means correct direction. In case the rotation is incorrect, cut off power and exchange the two power leads.

6) Automatic device

6.1) While using the automatic pump, in case it still operates after turning off the water tap, lower down power cut-off pressure of the pressure switch on the premise of pipeline without leakage, namely, rotate the variable screw nut IJ in counter-clockwise direction(-) to acquire lower Closed pressure.

6.2) In case the pump is often enabled when the water tap is turned off (sometimes it is turned on and sometimes it is turned off), check whether pipeline and the bottom valve have leakages and pressure vessel pressure is normal, eliminate timely if any.

6.3) In case the pressure switch is alternately turned on or turned off (frequent start) after turning on the water tap, increase power cut-off pressure of the pressure switch, namely, rotate the variable screw nut 1 in clockwise direction to acquire higher cut-in pressure.

9. START-UP AND MAINTENANCE

Do not start up the pump before the pump chamber is filled with water.

Do not touch the electric pump unless its power has been cut off for at least 5 minutes. Do not dismount the pump body unless water in the pump chamber is emptied.

Attention:

1) The pump chamber should be filled with water before first use and water refilling is unnecessary in the future.

2) In case no water is discharged after being started for more than 5 minutes with water filled, turn off the electric pump, re-fill water or check whether the inlet pipeline has leakages.

3) In case of any frost and ice damages, please open the drain plug to empty water in the pump chamber. When start up the pump again, open the drain plug, fill water and tighten it and then the pump is usable.

4) In case not use for a long time, water in the pump should be emptied. The pump body, impeller and support should be cleaned and coated with anticorrosive oil before they are put in a ventilated and dry place for use.

5) In case the pump is halted for a long time, start it up again according to above diagram.

6) In summer or when the ambient temperature is high, pay attention to ventilation, avoid dew on electrical parts which will result in electrical faults.

7) In case the motor is hot or abnormal, cut off the power immediately and check faults according to the following table.

10. TROUBLESHOOTING

PROBLEM	POSSIBLE CAUSE	REMEDY
The motor can not be started	Single-phase power supply (three-phase electric motor): a. poor connection of the power switch b. fuse is burned out c. loose power lead d. phase failure of the cable	a. repair switch contact or replace the switch b. replace the safety fuse c. check and tighten the power connector d. repair or replace cables
	Capacitor is burned out	Replace with a same type capacitor (send to the maintenance point for repair)
	The rotating shaft and bearing are jammed.	Replace the bearing (send to the maintenance point for repair)
	Impeller is jammed.	Turn rotating shaft of the fan blade terminal with screw driver to let it rotate flexibly or demount the pump body to clear sundries.
The motor is in operation, but no water is discharged	Stator winding is damaged	Replace winding coils (send to the maintenance point for repair)
	Incorrect direction of pump rotation	Invert two-phase wirings of the motor (three-phase motor)
	The pump is not fully filled with water	Re-fill the pump with water.
	The impeller is damaged	Replace the impeller (send to the maintenance point for repair)
	Leakage of the suction pipe	Check sealing of various joints of the inlet pipelines
	Water level is too low	Adjust installation height of the pump
	Freeze caused by accumulated water in the pipeline or the chamber	Start up the pump after ice is melted

PROBLEM	POSSIBLE CAUSE	REMEDY
Insufficient pressure	Incorrect pump type	Select suitable pump
	The inlet pipeline is too long or with too many bends, pipe diameter is not selected as required.	Apply the pipe with the stipulated diameter, and make the inlet pipe short.
	Inlet pipeline, filter screen or pump chamber is blocked by foreign materials	Clean pipeline, foot valve or pump chamber, clear sundries
Motor works intermittently or the stator winding is burned out	The impeller is jammed or overload operation for a long time	Clear sundries in the pump chamber; operate the pump under the rated flow as much as possible.
	Incorrect grounding, broken cable or the electric pump is hit by lightning.	Seek for the reason, and replace winding coils.



Jr. 25 N°280 Urb. Carabayllo Zona A Etapa II - Comas

Tel: (51) 7040656 | Cel: (51) 923 664 830

jproducto@enfoquecliente.com | www.doctordelaqua.com